

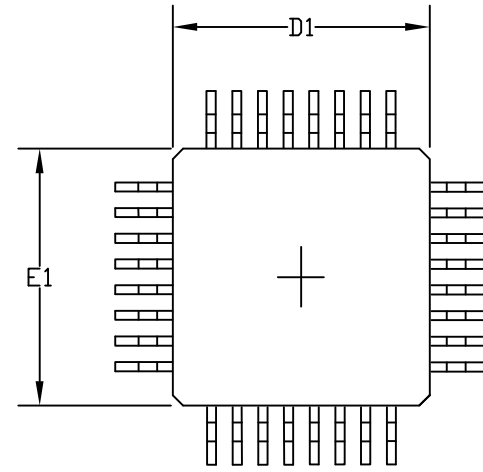

TOP VIEW

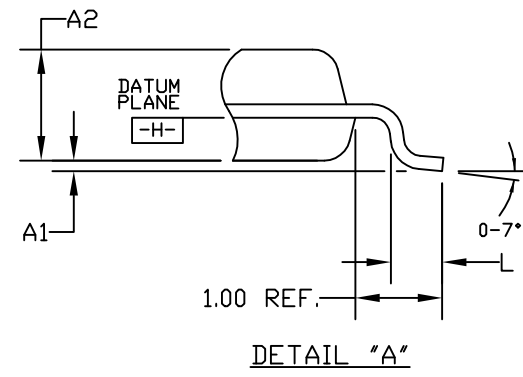

BOTTOM VIEW

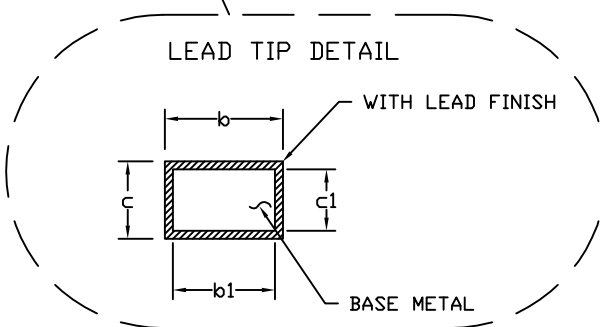
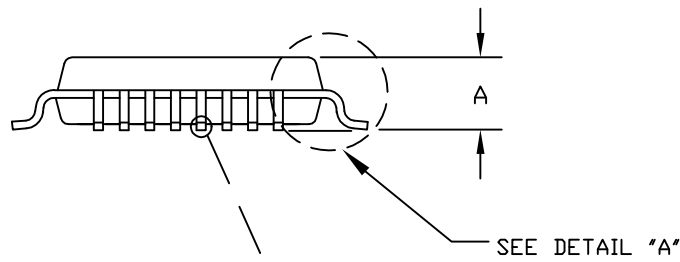

-DRAWING NOT TO SCALE-

 		
TITLE: PACKAGE OUTLINE, 32L TQFP, 5x5x1.0mm		
APPROVAL	DOCUMENT CONTROL NO. 21-0110	REV. B 1/2

NOTES:

1. ALL DIMENSIONING AND TOLERANCING CONFORM TO ANSI Y14.5-1982.
2. DATUM PLANE $\square H \square$ IS LOCATED AT MOLD PARTING LINE AND COINCIDENT WITH LEAD, WHERE LEAD EXITS PLASTIC BODY AT BOTTOM OF PARTING LINE.
3. DIMENSIONS D1 AND E1 DO NOT INCLUDE MOLD PROTRUSION. ALLOWABLE MOLD PROTRUSION IS 0.25 MM ON D1 AND E1 DIMENSIONS.
4. THE TOP OF PACKAGE IS SMALLER THAN THE BOTTOM OF PACKAGE BY 0.15 MILLIMETERS.
5. DIMENSION b DOES NOT INCLUDE DAMBAR PROTRUSION. ALLOWABLE DAMBAR PROTRUSION SHALL BE 0.08 MM TOTAL IN EXCESS OF THE b DIMENSION AT MAXIMUM MATERIAL CONDITION.
6. ALL DIMENSIONS ARE IN MILLIMETERS.
7. THIS OUTLINE CONFORMS TO JEDEC PUBLICATION 95, REGISTRATION MS-026.
8. LEADS SHALL BE COPLANAR WITHIN .004 INCH.
9. TOPMARK SHOWN IS FOR PACKAGE ORIENTATION REFERENCE ONLY.

JEDEC VARIATIONS DIMENSIONS IN MILLIMETERS		
AAA		
5x5x1.0 MM		
	MIN.	MAX.
A	\approx	1.20
A ₁	0.05	0.15
A ₂	0.95	1.05
D	6.80	7.20
D ₁	4.80	5.20
E	6.80	7.20
E ₁	4.80	5.20
L	0.45	0.75
N	32	
e	0.50 BSC.	
b	0.17	0.27
b ₁	0.17	0.23
c	0.09	0.20
c ₁	0.09	0.16

-DRAWING NOT TO SCALE-

			
TITLE:			
PACKAGE OUTLINE, 32L TQFP, 5x5x1.0mm			
APPROVAL	DOCUMENT CONTROL NO.	REV.	
	21-0110	B	2/2